

POHLED A

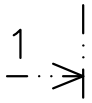

PŮDORYS

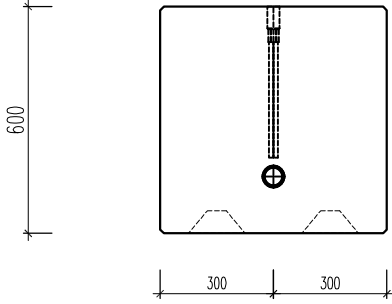
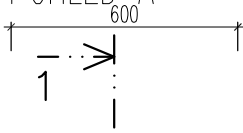
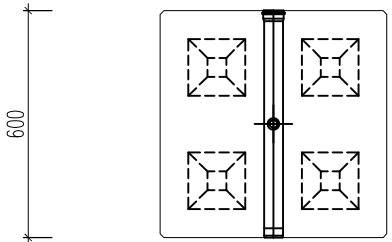
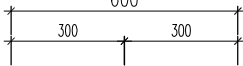

POHLED A

ŘEZ 1-1

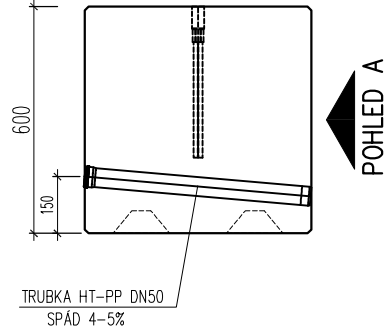
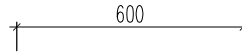

	Třída betonu: C 20/25 a vyšší
Rozměr: 600x600x600 mm	Váha: 515 kg
Měřítko: 1:20	Objem: 0,216 m ³

H-BLOK STANDARD 1/3 DREN U