

POHLED A

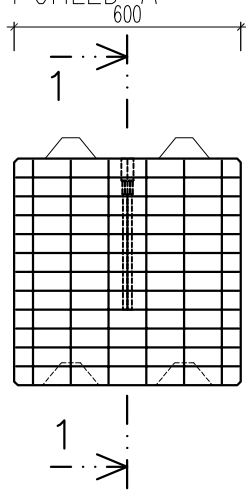

ŘEZ 1-1

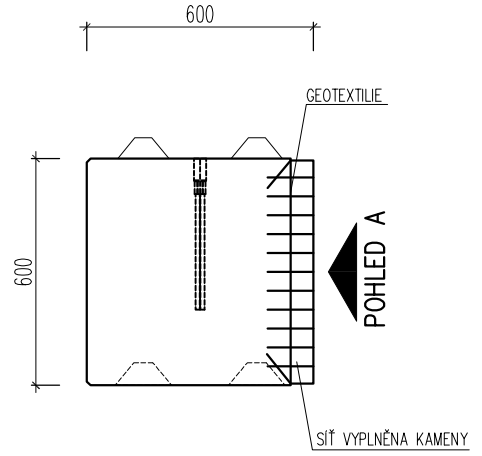

PŮDORYS

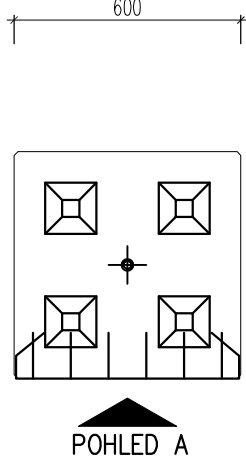

Designové varianty: čedič
žula
kubo

Třída betonu: C 20/25 a vyšší

Rozměr: 600x600x600 mm

Váha: 580 kg

Měřítko: 1:20

Objem: 0,216 m³

H-BLOK GABION 1/3